

# Technical data sheet

## Product features



### Display unit heated, bain marie tub GN 6-1/1 drop-in

<b>Model</b>	<b>SAP Code</b>	00012096
--------------	-----------------	----------



- Buffet type: RED - heated, Bain Marie
- Device properties: Warmed
- Number of GN / EN: 6
- GN / EN size in device: GN 1/1
- GN device depth: 200
- Minimum device temperature [°C]: 60
- Maximum device temperature [°C]: 90

<b>SAP Code</b>	00012096	<b>Loading</b>	230 V / 1N - 50 Hz
<b>Net Width [mm]</b>	650	<b>Number of GN / EN</b>	6
<b>Net Depth [mm]</b>	2144	<b>GN / EN size in device</b>	GN 1/1
<b>Net Height [mm]</b>	290	<b>GN device depth</b>	200
<b>Net Weight [kg]</b>	31.00	<b>Minimum device temperature [°C]</b>	60
<b>Power electric [kW]</b>	3.000	<b>Maximum device temperature [°C]</b>	90

# Technical data sheet

Technical drawing



Display unit heated, bain marie tub GN 6-1/1 drop-in

Model

SAP Code

00012096

A= ELECTRICAL CONNECTION  
 D= WATER DISCHARGE G1/2" (M) ONLY BM  
 E= WATER INLET G3/4" (M) ONLY BM

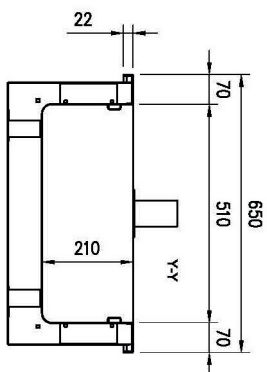
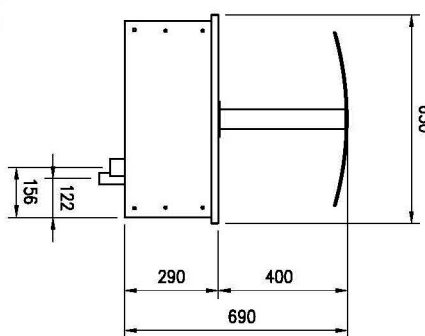
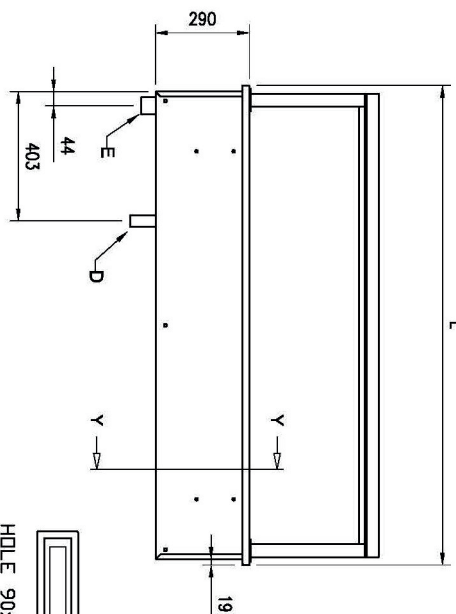
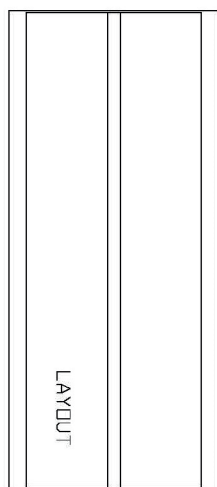

GN	L	HOLE
2/1	844	814x620
3/1	1169	1139x620
4/1	1494	1464x620
5/1	1819	1789x620
6/1	2144	2114x620

FLAT

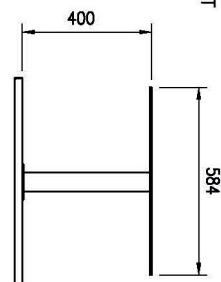

SERVICE

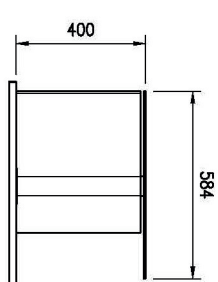

TRADITION

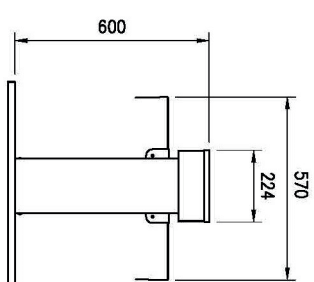

# Technical data sheet

## Product benefits



### Display unit heated, bain marie tub GN 6-1/1 drop-in

Model

SAP Code

00012096

1

#### **Built-in**

the possibility to plant in a dispensing block design

- unified design of the dispensing line
- a luxurious look that customers appreciate

2

#### **One large bathtub**

one controller for the whole bain  
one controller for the whole bain

- very easy to use
- easy maintenance

3

#### **GN insertion up to 200mm**

variability of use

- possibility of heating different types of food and larger volumes
- saving time, space, costs

4

#### **Rounded corners**

basins without sharp edges and corners

- higher hygienic safety
- time saving due to easy cleaning

5

#### **All-stainless steel construction**

basins without sharp edges and corners

- long service life
- very easy to clean

# Technical data sheet

Technical parameters



Display unit heated, bain marie tub GN 6-1/1 drop-in

Model

SAP Code

00012096

**1. SAP Code:**

00012096

**2. Net Width [mm]:**

650

**3. Net Depth [mm]:**

2144

**4. Net Height [mm]:**

290

**5. Net Weight [kg]:**

31.00

**6. Gross Width [mm]:**

730

**7. Gross depth [mm]:**

2230

**8. Gross Height [mm]:**

700

**9. Gross Weight [kg]:**

37.00

**10. Device type:**

Electric unit

**11. Material:**

AISI 304

**12. Buffet type:**

RED - heated, Bain Marie

**13. Device properties:**

Warmed

**14. Device color:**

Stainless steel

**15. Power electric [kW]:**

3.000

**16. Loading:**

230 V / 1N - 50 Hz

**17. Number of GN / EN:**

6

**18. GN / EN size in device:**

GN 1/1

**19. GN device depth:**

200

**20. Minimum device temperature [°C]:**

60

**21. Maximum device temperature [°C]:**

90

**22. Filling:**

Automatic